

1

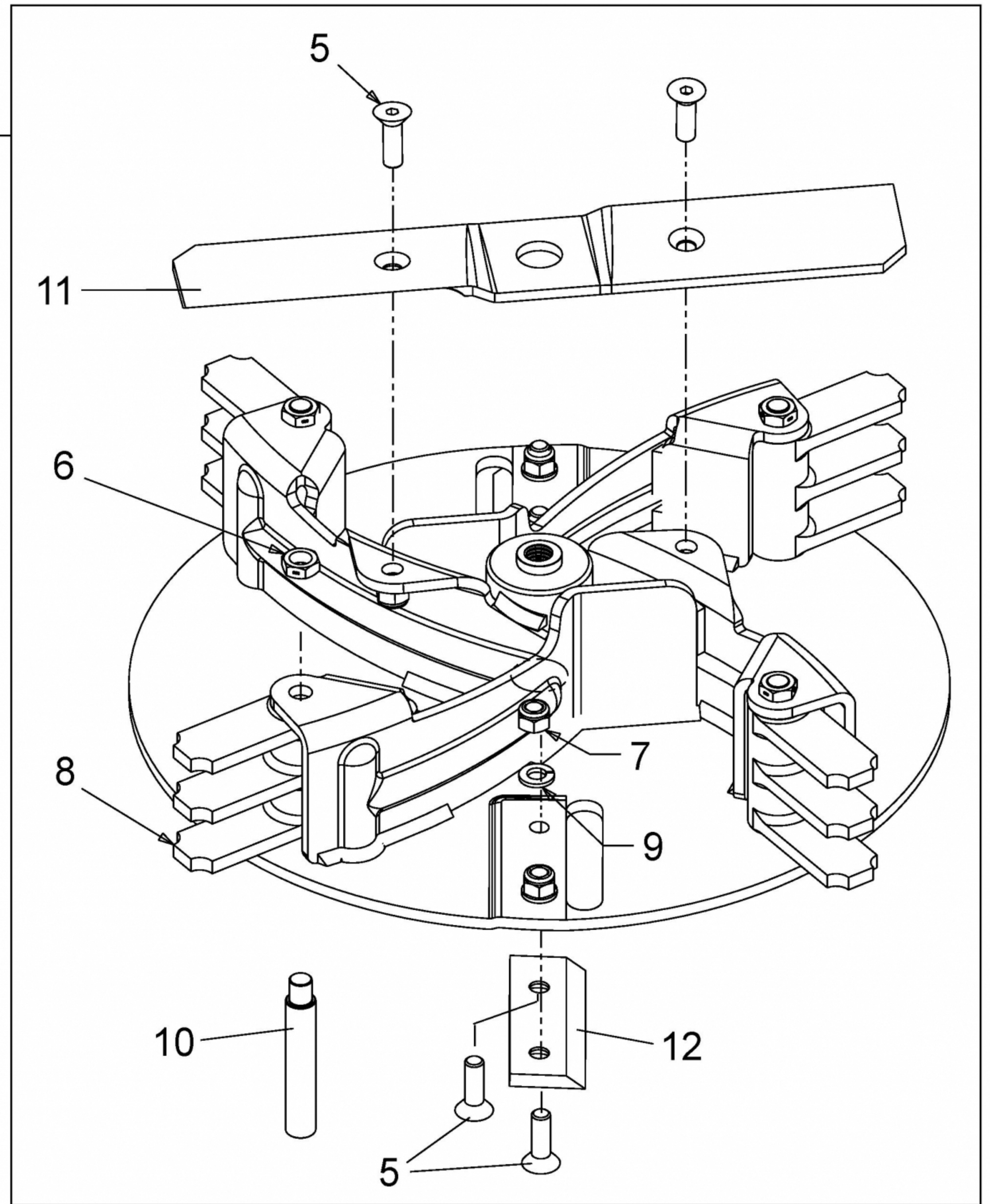

E3-07852A-01