

ab 03/04/2018
from 04/03/2018
à partir du 03/04/2018

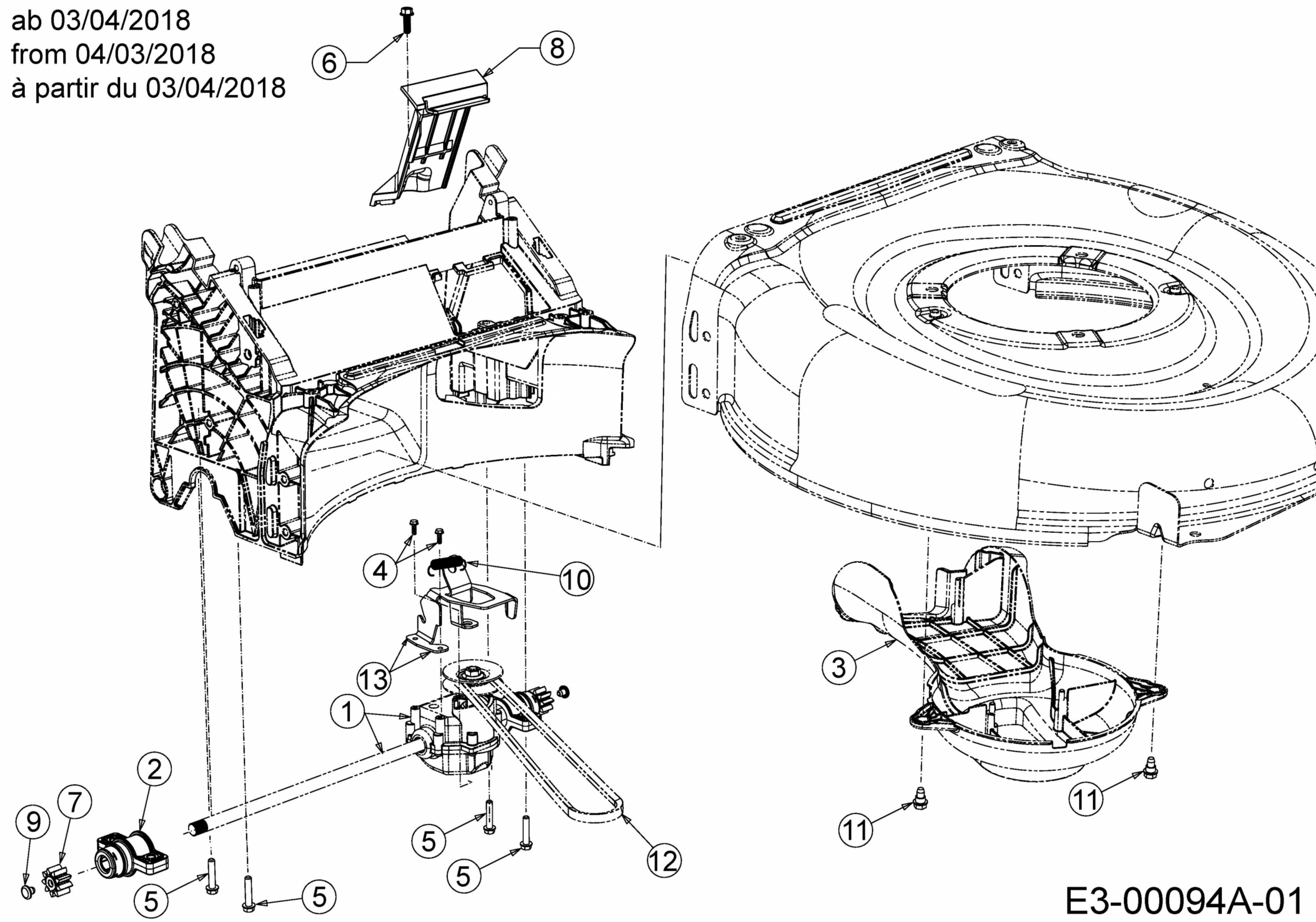

E3-00094A-01